



# ROYAL FILTERMIST MODEL FX-900



## FX-900 Specifications

Airflow	900 cfm
Fits machines with enclosure volume of:	90-180 cubic feet
Motor	3 HP (2.2 kW), 3-Phase, 50/60 Hz. Voltage & Current @ 60Hz. 208V - 9.2A 230V - 9.2A 460V - 4.6A
Weight	51 lbs.
Noise Level	70 dBA
Inlet Diameter	6"

## Mounting Options — FX-900

Direct Mount	use 30302 — FX-900 Direct Mount Kit
Floor Stand	use 30315 — Floor Stand "B"
Machine Top Stand	use 30314 — Machine Stand "B"
Wall Mount	use 30320 — Wall Bracket "B"
Machine Side Mount	use 30320 — Wall Bracket "B"

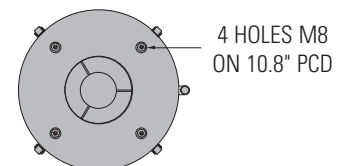
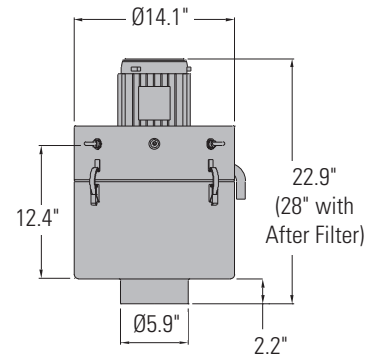
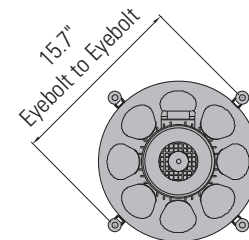

- ❑ For use on enclosed machines with an internal volume between 90 cu. ft. and 180 cu. ft.
- ❑ **Popular for open machines** requiring a Y-junction and two intake points.
- ❑ Unit can be mounted directly to the machine, on stands, on brackets, or suspended.
- ❑ Stainless steel model (type 304) available for special applications such as food processing and aqueous parts washers.



# ROYAL FILTERMIST MODEL FX-900



## Filtermist Units

DESCRIPTION	PART NUMBER	PRICE
 <b>FX-900 Filtermist Unit</b> Includes 12 ft. of coolant return hose. Order performance and mounting accessories separately.	30120	<b>\$3,695</b>
 <b>FX-900 Stainless Steel Unit</b>	30160	<b>\$5,935</b>

See Promo on Page 147











## Electrical Accessories

DESCRIPTION	PART NUMBER	PRICE
 <b>Starter Box Kit</b> Includes NEMA 12 box, IEC motor starter, 20 ft. of input cable, 15 ft. of output cable with turn-lock connector	FX-900 & 1200 Low-Voltage (208/230V) 30472	<b>\$585</b>
	FX-900 & 1200 High-Voltage (460V) 30473	<b>\$585</b>

## Performance Accessories

DESCRIPTION	PART NUMBER	PRICE
 <b>Standard After Filter "B"</b> Used for collecting dry smoke and very fine mist particles.	30205	<b>\$295</b>
	See Promo on Page 147	
 <b>High-Performance After Filter "B"</b> Designed for high pressure and Swiss applications. Extended operating life over standard after filter.	30204	<b>\$799</b>
 <b>Cyclonic Swarf Separator</b> For use on applications such as grinding and cast iron machining where very fine solid particles are entrained in the mist stream. Also acts as a great pre-filter for high pressure coolant applications. Requires 6" dia. ducting.	30210	<b>\$995</b>
 <b>Chip Deflector "B"</b> Protects intake from coolant splash and chips.	30220	<b>\$75</b>
 <b>Maintenance Monitor</b> Bright LED status indicator monitors performance and shows when maintenance is required.	30477	<b>\$640</b>

## Mounting Accessories

DESCRIPTION	PART NUMBER	PRICE
 <b>Direct Mount Kit (FX-900)</b> Includes 6" collar seal, set of rigid mounting studs, and hardware.	30302	<b>\$100</b>
 <b>Floor Stand "B"</b> Adjusts from 6 ft. to 9 ft. Bolts to floor for safety.	30315	<b>\$1,165</b>
 <b>Machine Top Stand "B"</b> 3 ft. tall stand bolts to the top of a machine.	30314	<b>\$640</b>
 <b>Wall Bracket "B"</b> Can be used to mount unit to a wall or other suitable mounting surface.	30320	<b>\$420</b>
 <b>Coolant Return Hose</b> 3/4" diameter. Note: Also included with unit. See description.	30335	<b>\$4/ft.</b>
 <b>Ducting</b> Flexible vinyl with heavy wire support.	8" 30344 6" 30342 4" 30340	<b>\$22/ft.</b> <b>16/ft.</b> <b>12/ft.</b>
Warning — never use sheetmetal ducting or any other type that could leak and cause a hazardous condition.		
 <b>Ducting Clamps</b> For securing ducting to accessories.	8" 30354 6" 30352 4" 30350	<b>\$7</b> <b>6</b> <b>6</b>
 <b>Y-Junctions</b> For multiple pickup locations.	A B 8" 6" 30368 8" 4" 30366 6" 6" 30364 6" 4" 30362 4" 4" 30360	<b>\$370</b> <b>460</b> <b>340</b> <b>320</b> <b>265</b>
 <b>Flange Adapters</b> For securing ducting directly to an enclosed machine.	8" 30374 6" 30372 4" 30370	<b>\$80</b> <b>75</b> <b>75</b>
 <b>Reducers</b>	A B 8" 6" 30382 6" 4" 30380	<b>\$145</b> <b>145</b>
 <b>Fishtails</b> For use on open machines.	A B 8" 11.75" x 5" 30394 6" 10" x 4.5" 30392 4" 8.25" x 3.5" 30390	<b>\$260</b> <b>240</b> <b>220</b>



Try a unit on your toughest application risk-free! See Page 147.